

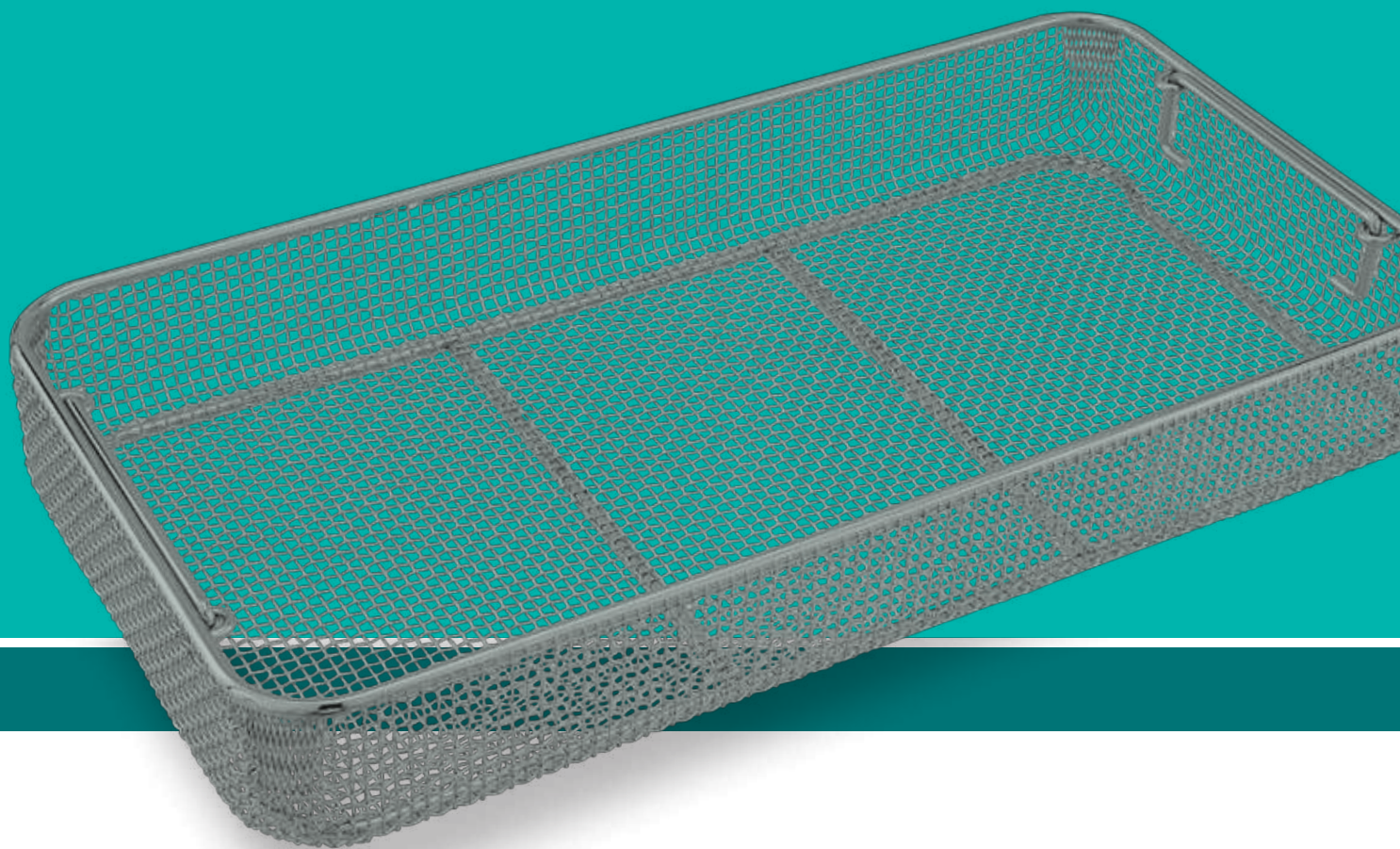

Surgical Holloware

# Volume 1



Handling  Sterilization

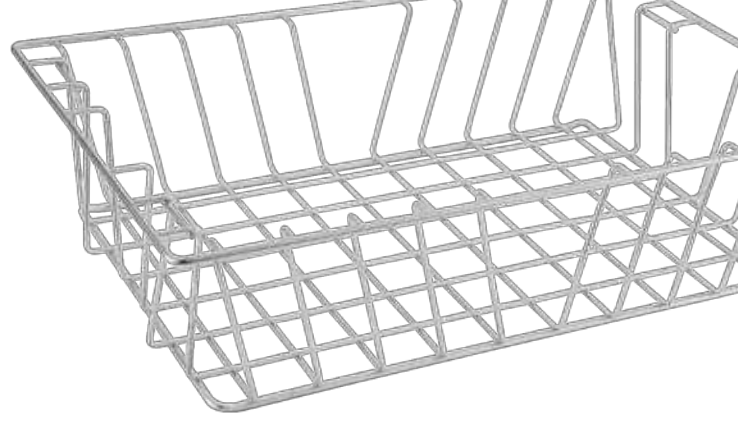

# Index

Page	Item
01	<b>001</b> Wire Mesh Baskets
03	<b>003</b> Fine Mesh BOX (with catch lock)
03	<b>007</b> Fine Mesh Baskets (with catch lock)
03	<b>012</b> Perforated Stainless Steel Micro Basket
04	<b>004</b> Fine Mesh Baskets (with locking clip)
04	<b>034</b> Ultra Fine Basket
05	<b>002</b> Flat Base Baskets
06	<b>015</b> Stainless Steel Inlays
07	<b>016</b> Fixing Clamps
09	<b>008</b> Micro Ophthalmic Basket
09	<b>010</b> Bipolar Forcep Basket
10	<b>009</b> Wire Net Basket
11	<b>005</b> Sterile Goods Baskets
12	<b>006</b> Baskets SPRI
13	<b>039</b> Basket Racks
14	<b>011</b> Endoscope Baskets
17	<b>022</b> Dental Instruments Cassettes
20	<b>030</b> Dental Instruments Clip In
20	<b>023</b> Micro Cassette
20	<b>031</b> Nomenclature Plates / Tags
21	<b>024</b> Implantology Cassettes
23	<b>025</b> Endodontic Cassettes
24	<b>028</b> Bur Clips
24	<b>029</b> Bur Holder & Stand

Page	Item
25	<b>018</b> Perforated Sheet Trays
25	<b>019</b> Edinburgh Aluminium Sheet Trays
26	<b>020</b> Trinket Boxes
26	<b>032</b> Medical / Laboratory Sieves
27	<b>021</b> Surgical Needle Cases
27	<b>055</b> Dental Box
27	<b>056</b> Test Tube Stand
27	<b>057</b> Endodontic Box
27	<b>014</b> PRF Box
28	<b>040</b> Instruments Tray
28	<b>042</b> Catheter Tray
28	<b>041</b> Instrument Box
28	<b>043</b> Kidney Trays
29	<b>044</b> Dressing Drum
29	<b>013</b> Bowls
29	<b>045</b> Dressing Jar
29	<b>046</b> Forceps Jar
29	<b>047</b> Waste Collector
29	<b>059</b> Cotton Dispenser
30	<b>051</b> Bed Pans
30	<b>052</b> Urinals
30	<b>054</b> Irrigator
30	<b>058</b> Scaler Trays
30	<b>053</b> Measuring Jug

001 WIRE MESH BASKETS



Item Code	Size in mm
CIL-001 008 001	480 x 360 x 30
CIL-001 008 002	480 x 360 x 50
CIL-001 008 003	480 x 360 x 60
CIL-001 008 004	480 x 360 x 70
CIL-001 008 005	480 x 360 x 100
CIL-001 009 001	480 x 480 x 30
CIL-001 009 002	480 x 480 x 50
CIL-001 009 003	480 x 480 x 60
CIL-001 009 004	480 x 480 x 70
CIL-001 009 005	480 x 480 x 100
CIL-001 010 001	515 x 245 x 30
CIL-001 010 002	515 x 245 x 50
CIL-001 010 003	515 x 245 x 60
CIL-001 010 004	515 x 245 x 70
CIL-001 010 005	515 x 245 x 100
CIL-001 011 001	540 x 250 x 30
CIL-001 011 002	540 x 250 x 50
CIL-001 011 003	540 x 250 x 60
CIL-001 011 004	540 x 250 x 70
CIL-001 011 005	540 x 250 x 100

Item Code	Size in mm
CIL-001 001 001	120 x 250 x 30
CIL-001 001 002	120 x 250 x 50
CIL-001 001 003	120 x 250 x 60
CIL-001 001 004	120 x 250 x 70
CIL-001 001 005	120 x 250 x 100
CIL-001 002 001	240 x 250 x 30
CIL-001 002 002	240 x 250 x 50
CIL-001 002 003	240 x 250 x 60
CIL-001 002 004	240 x 250 x 70
CIL-001 002 005	240 x 250 x 100
CIL-001 003 001	255 x 245 x 30
CIL-001 003 002	255 x 245 x 50
CIL-001 003 003	255 x 245 x 60
CIL-001 003 004	255 x 245 x 70
CIL-001 003 005	255 x 245 x 100
CIL-001 004 001	405 x 250 x 30
CIL-001 004 002	405 x 250 x 50
CIL-001 004 003	405 x 250 x 60
CIL-001 004 004	405 x 250 x 70
CIL-001 004 005	405 x 250 x 100
CIL-001 005 001	405 x 255 x 30
CIL-001 005 002	405 x 255 x 50
CIL-001 005 003	405 x 255 x 60
CIL-001 005 004	405 x 255 x 70
CIL-001 005 005	405 x 255 x 100
CIL-001 006 001	480 x 250 x 30
CIL-001 006 002	480 x 250 x 50
CIL-001 006 003	480 x 250 x 60
CIL-001 006 004	480 x 250 x 70
CIL-001 006 005	480 x 250 x 100
CIL-001 007 001	485 x 255 x 30
CIL-001 007 002	485 x 255 x 50
CIL-001 007 003	485 x 255 x 60
CIL-001 007 004	485 x 255 x 70
CIL-001 007 005	485 x 255 x 100





■ ■ **001 LID WIRE MESH BASKETS**

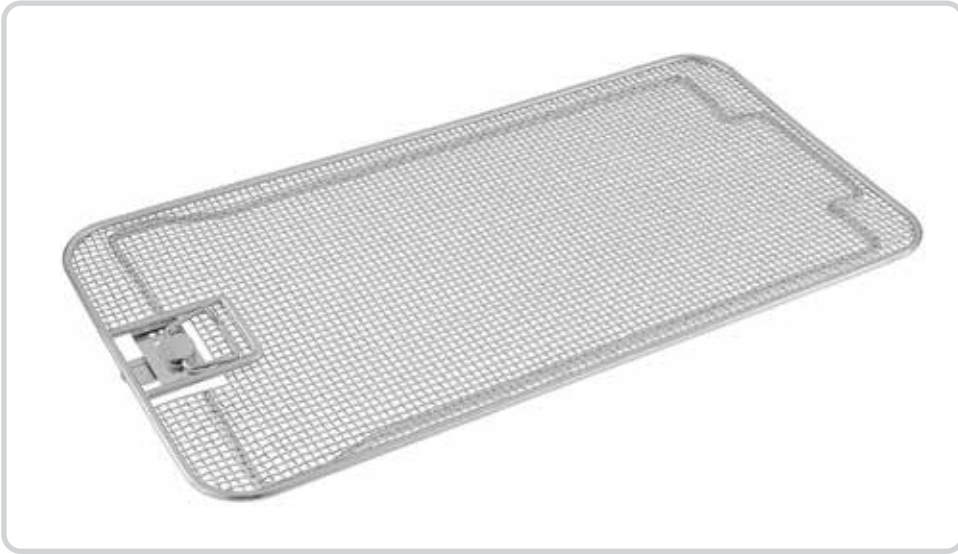

**(Double Frame)**

Item Code	Size in mm
CIL-001 001 501	120 x 250
CIL-001 002 501	240 x 250
CIL-001 003 501	255 x 245
CIL-001 004 501	405 x 250
CIL-001 005 501	405 x 255
CIL-001 006 501	480 x 250
CIL-001 007 501	485 x 255
CIL-001 008 501	480 x 360
CIL-001 009 501	480 x 480
CIL-001 010 501	515 x 245
CIL-001 011 501	540 x 250



*The wire mesh baskets are used as sterilizer accessories for medical & surgical products in laboratory sterilizers.*

*Available in drop and stay handle.*

*Custom sizes are offered.*

*Upto 1/2 din size top & bottom frame wire diameter 5.0mm.*

*Rest of the sizes top & bottom frame wire diameter 6.0mm.*

*Wire mesh with opening square 4.2mm. The wire diameter is 0.9mm.*

*Baskets are stackable.*

*Burr free smooth finish.*

*Electrolyte polish.*

**003 FINE MESH BOX WITH CATCH LOCK**



Item Code	Size in mm
CIL-003 001 001	120 x 155 x 40
CIL-003 002 001	235 x 155 x 40
CIL-003 003 001	275 x 200 x 40

The fine mesh boxes are used for small medical and surgical products

- Available in separate top cover, removable hinges and catch lock.
- Burr free smooth finish.
- Electrolyte polish.

**007 FINE MESH BASKET WITH CATCH LOCK**

Item Code	Size in mm
CIL-007 001 001	235 x 80 x 30

- Fine mesh with opening square 1.6 mm and wire diameter 0.5 mm.
- Burr free smooth finish.
- Electrolyte polish.

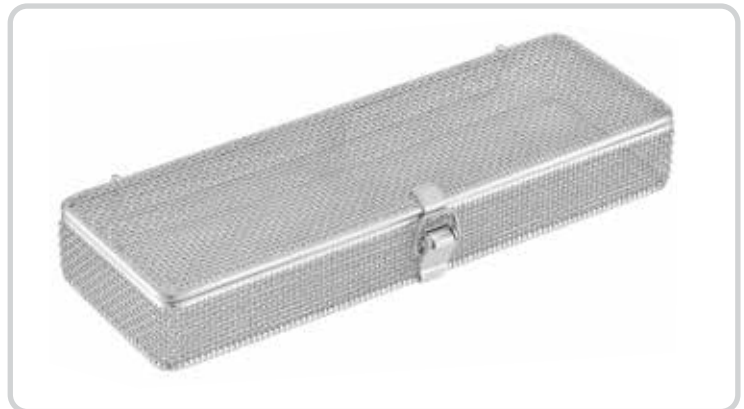

**012 PERFORATED STAINLESS STEEL MICRO BASKET**



Item Code	Size in mm
CIL-012 001 001	70 x 70 x 30
CIL-012 002 001	80 x 40 x 20
CIL-012 003 001	80 x 80 x 40
CIL-012 004 001	90 x 90 x 50
CIL-012 005 001	100 x 100 x 50
CIL-012 006 001	150 x 40 x 20
CIL-012 007 001	150 X 50 X 35
CIL-012 008 001	160 X 40 X 20
CIL-012 009 001	200 x 50 x 50

## 004 FINE MESH BASKETS WITH LOCKING CLIP

Item Code	Size in mm
CIL-004 001 001	40 x 40 x 20
CIL-004 001 002	40 x 40 x 30
CIL-004 002 001	70 x 70 x 30
CIL-004 003 001	80 x 40 x 20
CIL-004 003 002	80 x 40 x 30
CIL-004 004 001	80 x 80 x 34
CIL-004 004 002	80 x 80 x 40
CIL-004 004 003	80 x 80 x 50
CIL-004 005 001	90 x 90 x 50
CIL-004 006 001	100 x 100 x 50
CIL-004 007 001	105 x 70 x 25
CIL-004 008 001	150 x 50 x 35
CIL-004 009 001	190 x 85 x 100
CIL-004 010 001	200 x 100 x 35
CIL-004 011 001	220 x 140 x 50
CIL-004 012 001	235 x 155 x 40
CIL-004 013 001	240 x 90 x 40
CIL-004 014 001	240 x 120 x 35
CIL-004 015 001	275 x 175 x 35
CIL-004 016 001	275 x 200 x 35

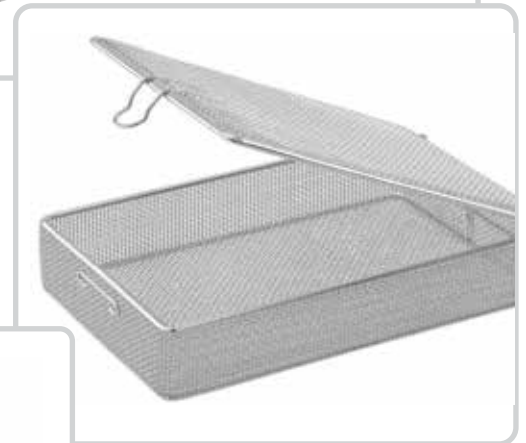
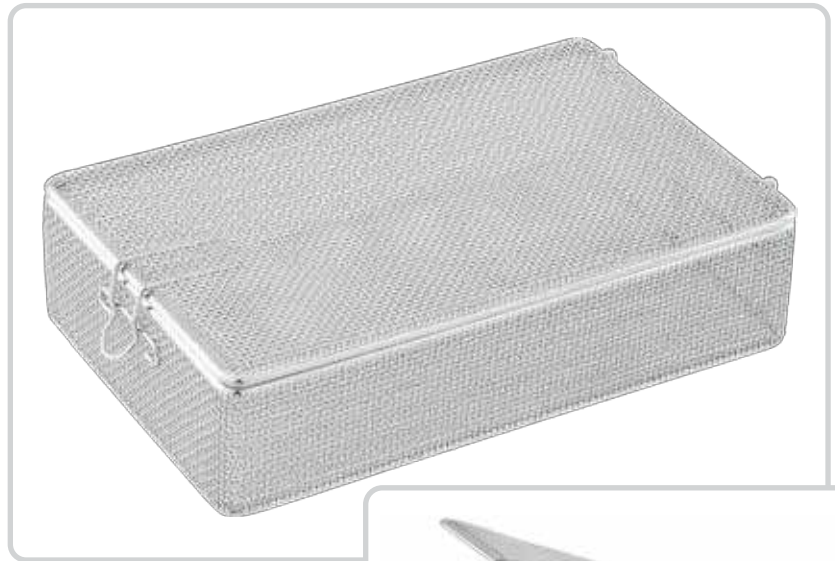

*Stainless steel fine mesh baskets are used for micro medical and surgical instruments.*

- Top and lid frame wire diameter 3.5 mm and 4.0 mm (according to the size of the baskets).
- Fine mesh with opening square 1.6 mm and wire diameter 0.7 mm.
- Wire locking clip.
- Electrolyte polish.
- Custom sizes are offered.



*Ultra fine baskets are used for delicate micro surgical and laboratory instruments for sterilization.*

- Top and lid frame wire diameter 3.0 mm
- Ultra fine mesh with opening square 0.5 mm and wire diameter 0.3 mm.
- Wire locking clip.
- Electrolyte polish.

Item Code	Size in mm
CIL-034 001 001	80 x 40 x 30
CIL-034 002 001	80 x 80 x 34
CIL-034 003 001	180 x 130 x 20
CIL-034 004 001	100 x 100 x 50
CIL-034 005 001	230 x 100 x 60
CIL-034 006 001	240 x 120 x 60

## 034 ULTRA FINE BASKET



■ ■ **002** FLAT BASE BASKETS



Item Code	Size in mm
CIL-002 001 001	120 x 250 x 30
CIL-002 001 002	120 x 250 x 50
CIL-002 001 003	120 x 250 x 60
CIL-002 001 004	120 x 250 x 70
CIL-002 001 005	120 x 250 x 100
CIL-002 002 001	240 x 250 x 30
CIL-002 002 002	240 x 250 x 50
CIL-002 002 003	240 x 250 x 60
CIL-002 002 004	240 x 250 x 70
CIL-002 002 005	240 x 250 x 100
CIL-002 003 001	255 x 245 x 30
CIL-002 003 002	255 x 245 x 50
CIL-002 003 003	255 x 245 x 60
CIL-002 003 004	255 x 245 x 70
CIL-002 003 005	255 x 245 x 100
CIL-002 004 001	405 x 250 x 30
CIL-002 004 002	405 x 250 x 50
CIL-002 004 003	405 x 250 x 60
CIL-002 004 004	405 x 250 x 70
CIL-002 004 005	405 x 250 x 100
CIL-002 005 001	405 x 255 x 30
CIL-002 005 002	405 x 255 x 50
CIL-002 005 003	405 x 255 x 60
CIL-002 005 004	405 x 255 x 70
CIL-002 005 005	405 x 255 x 100
CIL-002 006 001	480 x 250 x 30
CIL-002 006 002	480 x 250 x 50
CIL-002 006 003	480 x 250 x 60
CIL-002 006 004	480 x 250 x 70
CIL-002 006 005	480 x 250 x 100
CIL-002 007 001	485 x 255 x 30
CIL-002 007 002	485 x 255 x 50
CIL-002 007 003	485 x 255 x 60
CIL-002 007 004	485 x 255 x 70
CIL-002 007 005	485 x 255 x 100

Item Code	Size in mm
CIL-002 008 001	480 x 360 x 30
CIL-002 008 002	480 x 360 x 50
CIL-002 008 003	480 x 360 x 60
CIL-002 008 004	480 x 360 x 70
CIL-002 008 005	480 x 360 x 100
CIL-002 009 001	480 x 480 x 30
CIL-002 009 002	480 x 480 x 50
CIL-002 009 003	480 x 480 x 60
CIL-002 009 004	480 x 480 x 70
CIL-002 009 005	480 x 480 x 100
CIL-002 010 001	515 x 245 x 30
CIL-002 010 002	515 x 245 x 50
CIL-002 010 003	515 x 245 x 60
CIL-002 010 004	515 x 245 x 70
CIL-002 010 005	515 x 245 x 100
CIL-002 011 001	540 x 250 x 30
CIL-002 011 002	540 x 250 x 50
CIL-002 011 003	540 x 250 x 60
CIL-002 011 004	540 x 250 x 70
CIL-002 011 005	540 x 250 x 100





## 002 LID FLAT BASE BASKETS



Item Code	Size in mm
CIL-002 001 501	120 x 250
CIL-002 002 501	240 x 250
CIL-002 003 501	255 x 245
CIL-002 004 501	405 x 250
CIL-002 005 501	405 x 255
CIL-002 006 501	480 x 250
CIL-002 007 501	485 x 255
CIL-002 008 501	480 x 360
CIL-002 009 501	480 x 480
CIL-002 010 501	515 x 245
CIL-002 011 501	540 x 250

The flat base baskets are used as sterilizer accessories for medical & surgical products in laboratory sterilizers

- Separate lids are available.
- Available in various dimensions.
- Burr free side walls with perforated sheet
- Base in **wire net** with opening square 6.0 mm and wire diameter 1.2 mm
- Base also available in **wire mesh** with opening square 4.2 mm and wire diameter 0.9 mm
- Inner mounted drop handles
- Stay Handle
- Smooth finish electrolyte polish
- Custom sizes are offered.



## 015 STAINLESS STEEL INLAYS

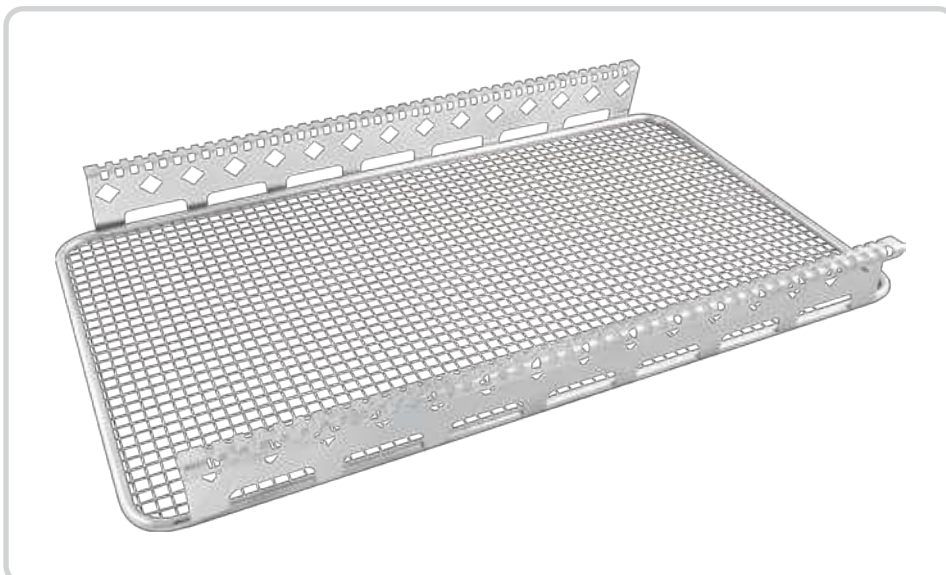

Item Code	Size in mm
CIL-015 001 001	226 x 258 x 30
CIL-015 001 002	226 x 258 x 45
CIL-015 002 001	431 x 258 x 30
CIL-015 002 002	431 x 258 x 45





■ ■ **016** FIXING CLAMPS

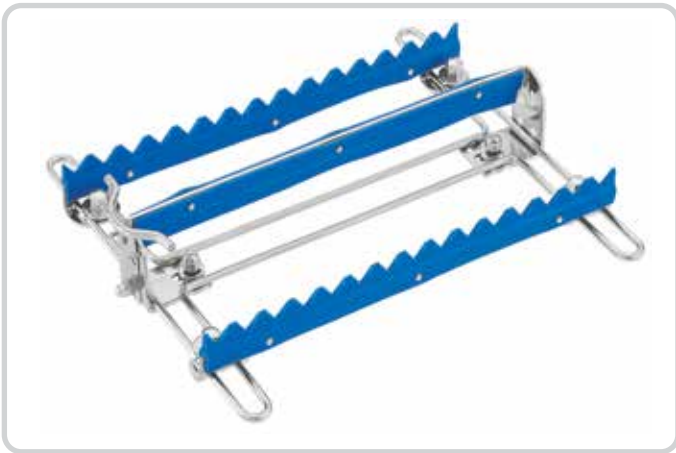
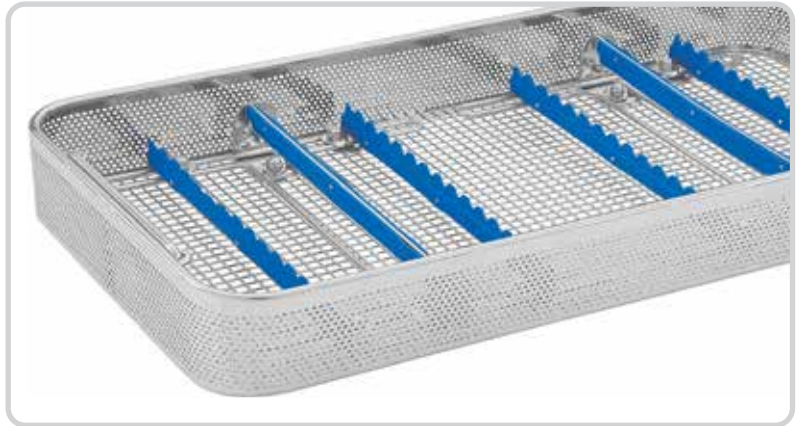

Item Code	Size in mm
CIL-016 001 001	60/220 x 220 x 39
CIL-016 002 001	60/220 x 210 x 39

Item Code	Size in mm
CIL-016 003 001	60 x 220 x 39
CIL-016 004 001	230 x 220 x 39

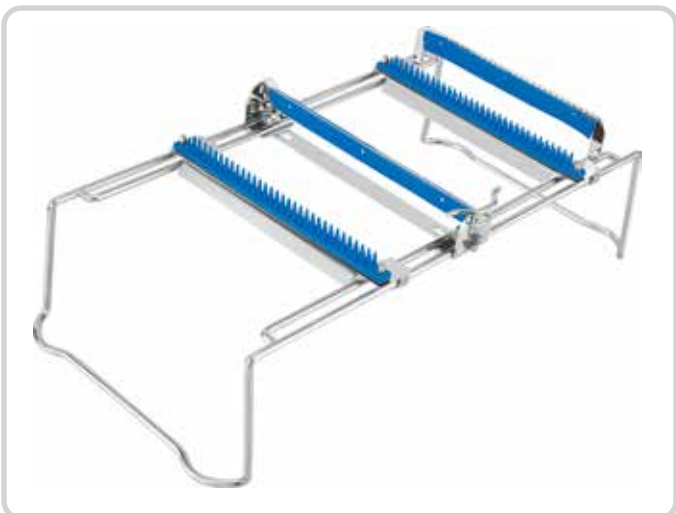
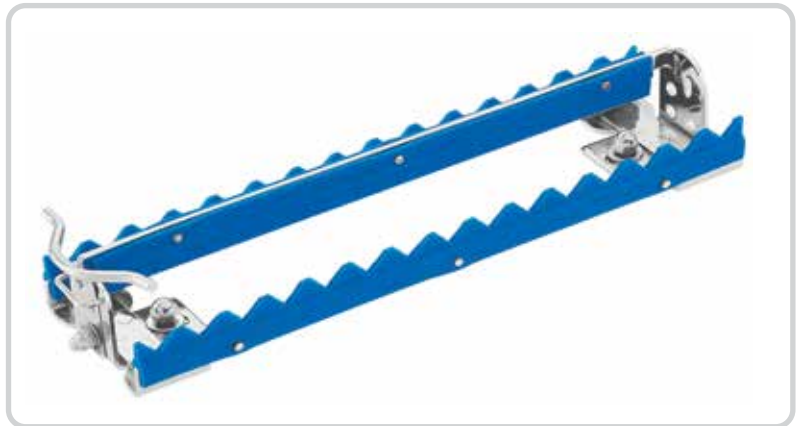

Item Code	Size in mm
CIL-016 005 001	465 x 220 x 100
CIL-016 005 002	465 x 220 x 155
CIL-016 006 001	525 x 220 x 100

■ ■ **016** FIXING CLAMPS



Item Code      Size in mm  
 CIL-016 007 001      225 x 220 x 39



Item Code      Size in mm  
 CIL-016 008 001      225 x 220 x 45



Item Code      Size in mm  
 CIL-016 009 001      465 x 220 x 39

Item Code      Size in mm  
 CIL-016 010 001      465 x 220 x 45



Item Code      Size in mm  
 CIL-016 011 001      465 x 220 x 39



*Fixing clamps are designed to accommodate the delicate scopic operating laboratory instruments in such a manner that a user can easily lift and place the instrument back during usage and for safe handling processes of sterilization and disinfection. Clamps are adjustable to instruments of any size.*

## 008 MICRO OPHTHALMIC BASKET



Item Code	Size in mm
CIL-008 001 001	240 x 250 x 40
CIL-008 002 001	340 x 250 x 40
CIL-008 003 001	440 x 250 x 40



Micro ophthalmic baskets are specially designed for delicate micro instruments.

- With silicon inserts on bottom of baskets to accommodate micro instruments.
- Lids are supplied with silicon strips to grip the instruments.
- Side walls are made of perforated sheet.
- User friendly locking handle.
- Burr free smooth finish
- Electrolyte polish

## 010 BIPOLAR FORCEP BASKET



Item Code	Size in mm
CIL-010 001 001	240 x 250 x 38
CIL-010 002 001	400 x 250 x 38
CIL-010 003 001	480 x 250 x 38

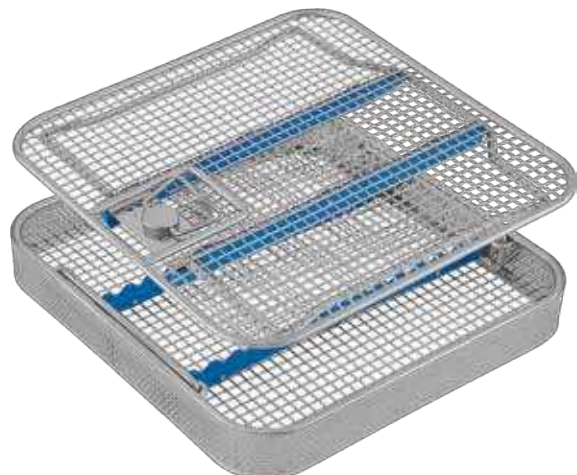

009 WIRE NET BASKET



Item Code	Size in mm
CIL-009 001 001	250 x 170 x 70
CIL-009 002 001	340 x 250 x 70
CIL-009 003 001	450 x 340 x 70

Wire net baskets are used for sterilization of instruments in a sterilizer.

- Bottom frame fabricated to allow space between instruments and working surface
- Separate top covers are available
- Stackable
- Top and bottom frame wire diameter 3.5 mm
- Grid made from wire diameter 1.6 mm having opening square 6.4 mm
- Burr free smooth finish
- Electrolyte polish

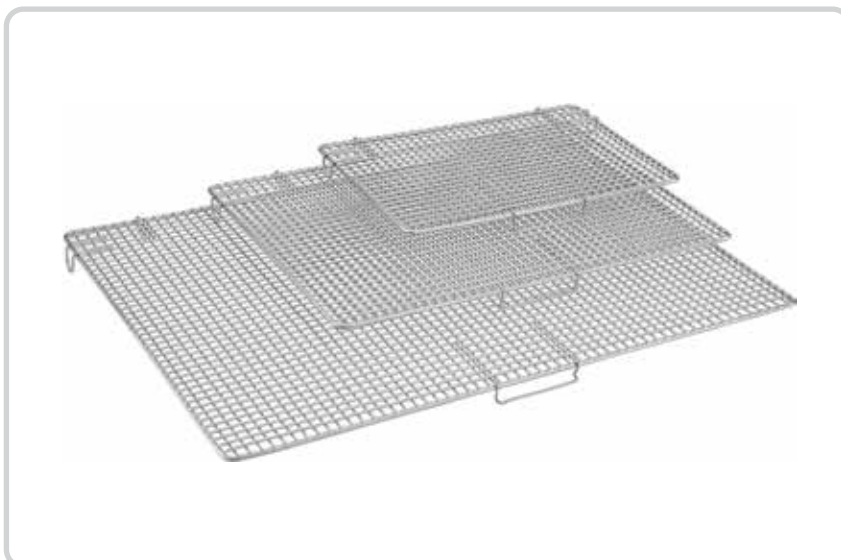
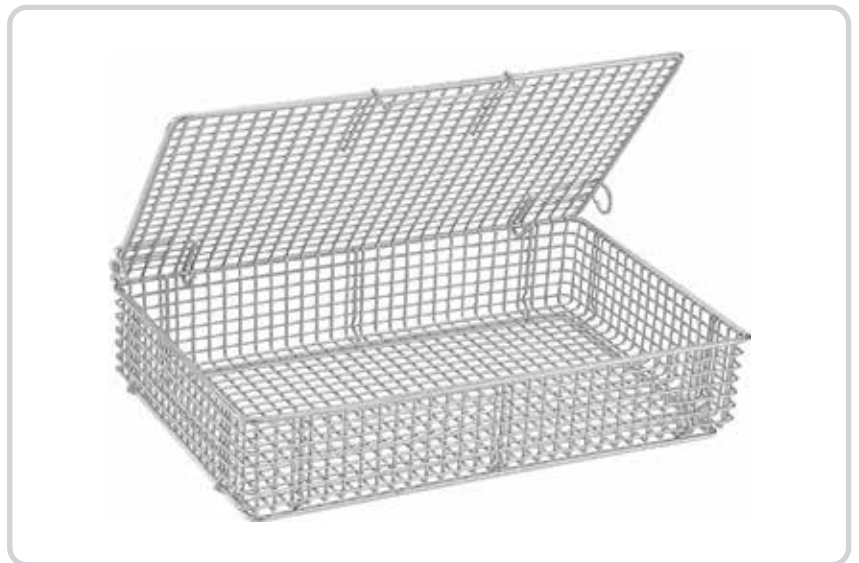

009 LID WIRE NET

Item Code	Size in mm
CIL-009 001 501	250 x 170
CIL-009 002 501	340 x 250
CIL-009 003 501	450 x 340



■ ■ **005** STERILE GOODS BASKETS

Standard

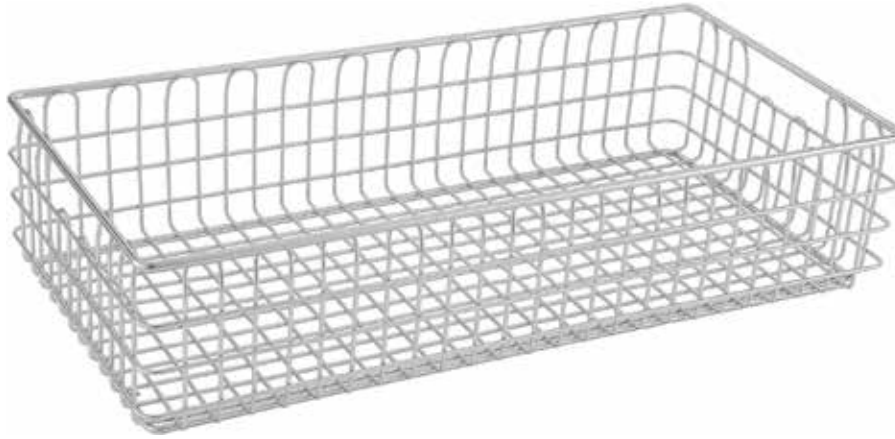

Item Code	Size in mm	Quality
CIL-005 001 001	575 x 280 x 135	Standard
CIL-005 001 002	575 x 280 x 265	Standard
CIL-005 001 003	575 x 280 x 265	Front access
CIL-005 002 001	600 x 300 x 150	Standard
CIL-005 002 002	600 x 300 x 260	Front access
CIL-005 002 003	600 x 300 x 300	Standard
CIL-005 002 004	600 x 300 x 300	Front access
CIL-005 003 001	600 x 400 x 150	Standard
CIL-005 003 002	600 x 400 x 300	Standard
CIL-005 003 003	600 x 400 x 300	Front access

Front access



The standard baskets are used for all types of sterilizers. STE sterile goods baskets mean the baskets made with continuous wire which provide maximum protection to user from being injured. The baskets are stackable and can also be mounted on the cart or wall with hooks.

- Upper frame wire diameter 6.0 mm.
- Frame wire diameter 3.0 mm.
- Loops wire diameter 2.5 mm.
- Bottom frame wire diameter 5.0 mm.
- Electrolyte polish and burr free smooth finish.

**006 BASKETS SPRI**

**Double Frame with folding handle**



- Upper and lower frame wire diameter 5.0 mm.
- Loops wire diameter 3.5 mm.

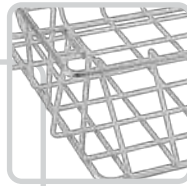

**(With folding handle)**

Item Code	Size in mm
CIL-006 001 001	585 x 395 x 100
CIL-006 001 002	585 x 395 x 195
CIL-006 002 001	600 x 300 x 97
CIL-006 002 002	600 x 300 x 138
CIL-006 002 003	600 x 300 x 150
CIL-006 002 004	600 x 300 x 260
CIL-006 002 005	600 x 300 x 300
CIL-006 002 006	600 x 300 x 50

Item Code	Size in mm
CIL-006 003 001	600 x 400 x 100

**Double Frame with large folding handle**



- Space for placing nomenclature plate.
- Upper and lower frame wire diameter 5.0 mm.
- Loops wire diameter 3.5 mm.

**Double Frame**

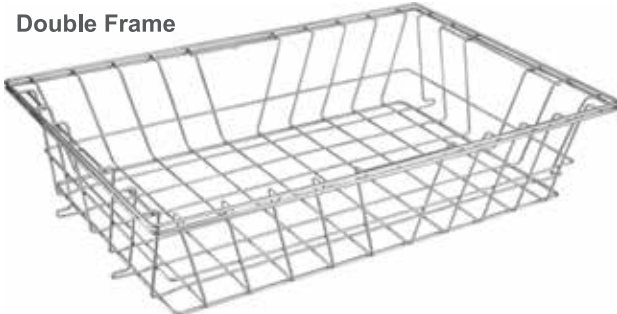

- Upper and lower frame wire diameter 5.0 mm.
- Loops wire diameter 3.5 mm.

Item Code	Size in mm
CIL-006 004 001	600 x 400 x 100
CIL-006 004 002	600 x 400 x 130
CIL-006 004 003	600 x 400 x 150
CIL-006 004 004	600 x 400 x 180

Item Code	Size in mm
CIL-006 005 001	600 x 400 x 100
CIL-006 005 002	600 x 400 x 130
CIL-006 005 003	600 x 400 x 150
CIL-006 005 004	600 x 400 x 180
CIL-006 005 005	600 x 400 x 200
CIL-006 006 001	600 x 300 x 50
CIL-006 006 002	600 x 300 x 100
CIL-006 006 003	600 x 300 x 130
CIL-006 006 004	600 x 300 x 150
CIL-006 006 005	600 x 300 x 180
CIL-006 006 006	600 x 300 x 200

**Single Frame**

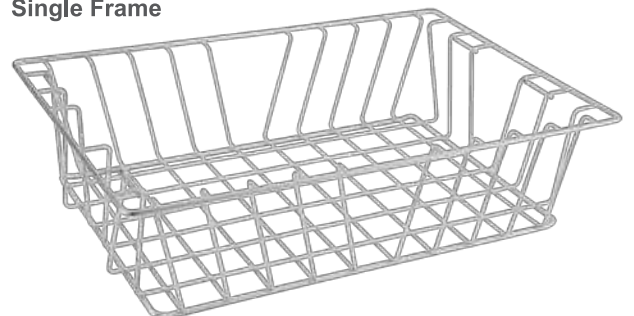

- Nestable/Stackable with change of position of placing of baskets on each other
- Upper and lower frame wire diameter 6.0 mm
- Loops wire diameter 4.0 mm

**Common Features**

- The SPRI baskets are both stackable and nestable
- Empty baskets occupy minimum storage space while nesting position
- Stackable when placed on one another in opposite position
- Electrolyte polish and smooth finish



■ ■ **039 BASKET RACKS**

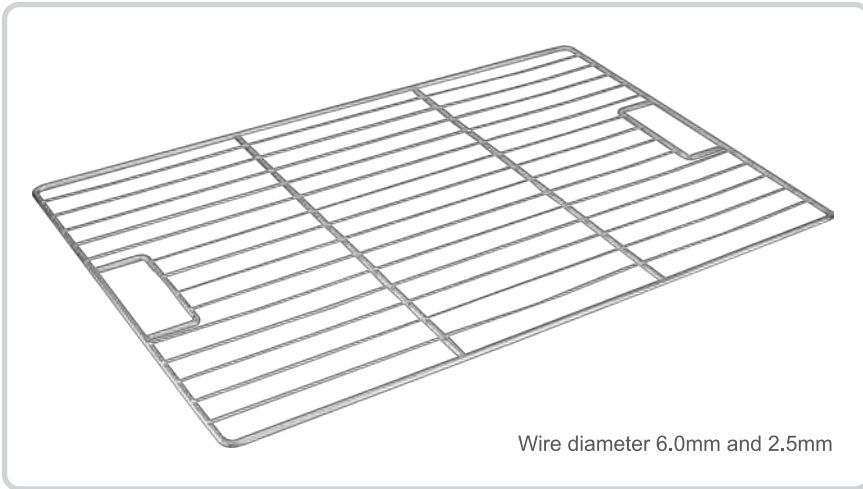

Item Code      Size in mm  
CIL-039 001 001      600 x 400 x 15

Wire diameter 6.0mm and 2.5mm

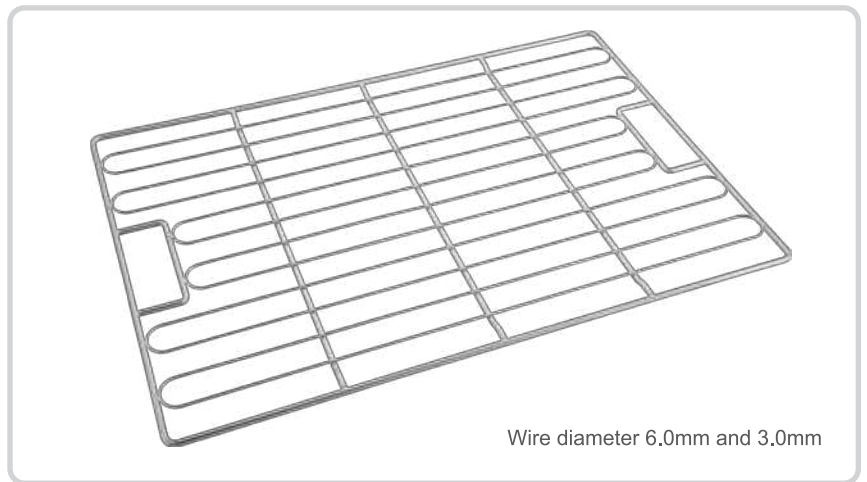

Item Code      Size in mm  
CIL- 039 004 001      600 x 400 x 15

Wire diameter 6.0mm and 3.0mm



Item Code      Size in mm  
CIL- 039 002 001      600 x 400 x 44

Wire diameter 6.0mm and 3.0mm

- *The sterilization baskets are placed on racks during sterilization.*

■ ■ **011** ENDOSCOPE BASKETS

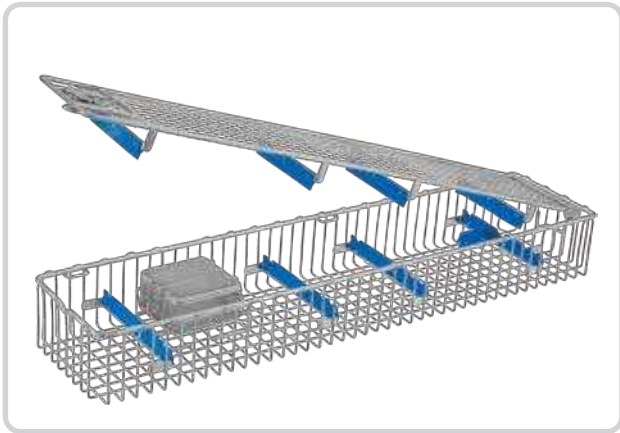

<u>Item Code</u>	<u>Size in mm</u>
CIL-011 001 001	640 x 150 x 77



**ARTHOSCOPE BASKET**

<u>Item Code</u>	<u>Size in mm</u>
CIL-011 002 001	290 x 80 x 52
CIL-011 003 001	180 x 80 x 52

<u>Item Code</u>	<u>Size in mm</u>
CIL-011 002 002	290 x 80 x 52

**ENDOSCOPE BASKET**

<u>Item Code</u>	<u>Size in mm</u>
CIL-011 004 001	460 x 80 x 52

<u>Item Code</u>	<u>Size in mm</u>
CIL-011 004 002	460 x 80 x 52





■ ■ **011** ENDOSCOPE BASKETS

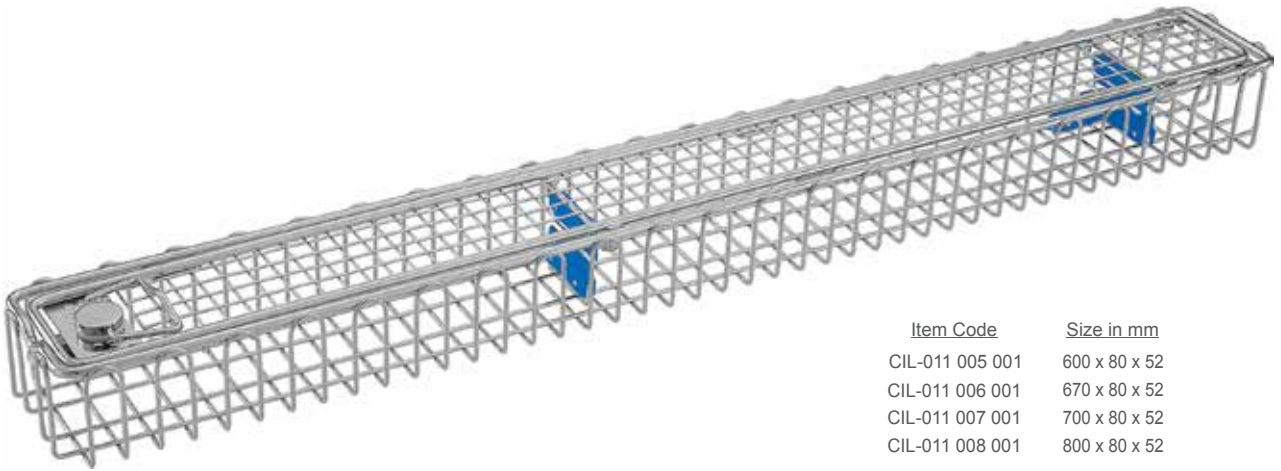

Item Code	Size in mm
CIL-011 005 001	600 x 80 x 52
CIL-011 006 001	670 x 80 x 52
CIL-011 007 001	700 x 80 x 52
CIL-011 008 001	800 x 80 x 52



Item Code	Size in mm
CIL-011 009 001	290 x 160 x 52



Item Code	Size in mm
CIL-011 009 002	290 x 160 x 52

Item Code	Size in mm
CIL-011 010 001	460 x 160 x 52



Item Code	Size in mm
CIL-011 010 002	460 x 160 x 52



Item Code	Size in mm
CIL-011 010 003	460 x 160 x 52





■ ■ **011** ENDOSCOPE BASKETS

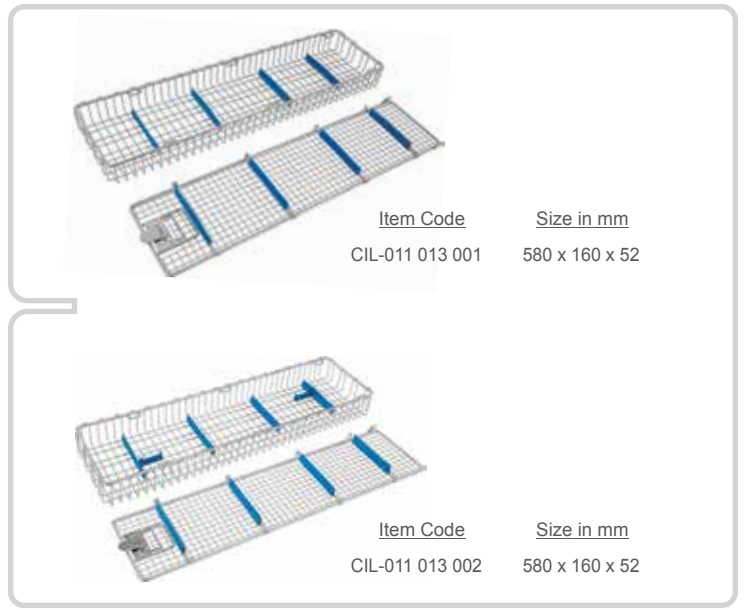
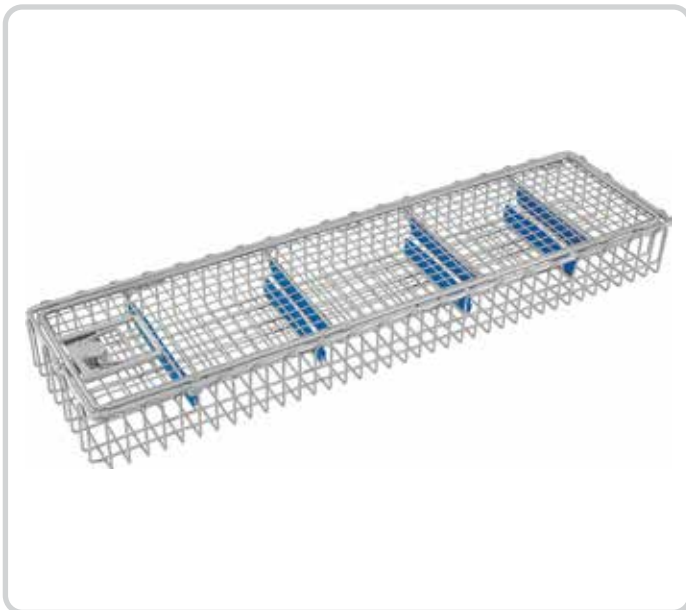
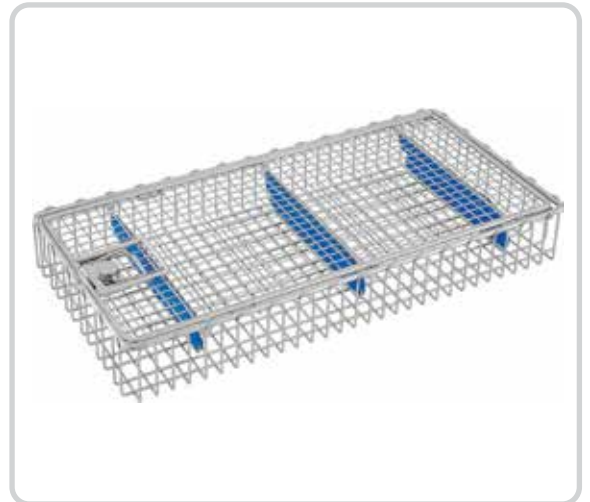
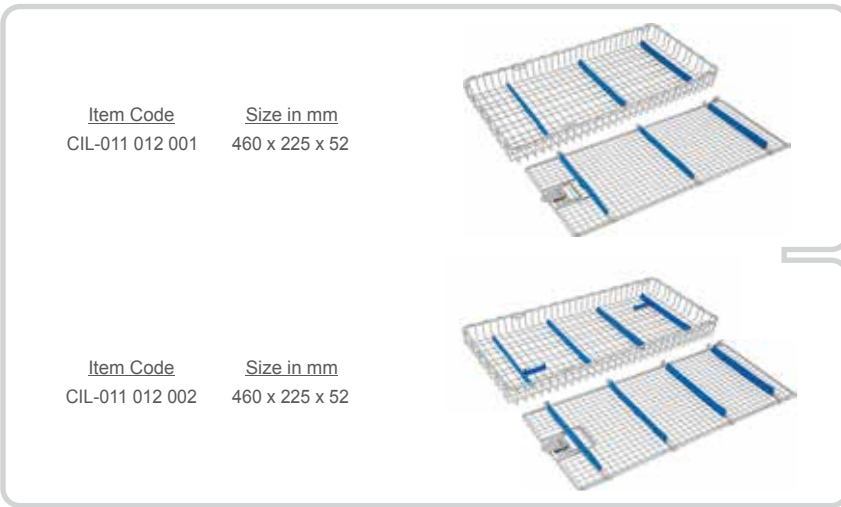
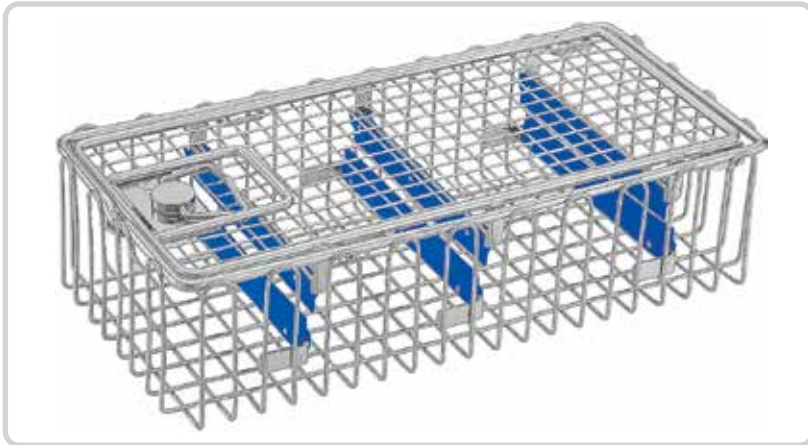

Endoscope baskets provide the safety to costly endoscopes during sterilization processes. The silicon padding also provides protection to medical & laboratory endoscopes.

- Top and lid frame wire diameter 5.0 mm
- Loops wire diameter 2.0 mm
- Autoclaveable silicon inserts
- Electrolyte polish and burr free finish

022 DENTAL INSTRUMENTS CASSETTES



Item Code	Size in mm
CIL-022 001 001	180 x 60 x 22
CIL-022 002 001	180 x 125 x 22



Item Code	Size in mm
CIL-022 003 001	184 x 74 x 34
CIL-022 004 001	184 x 145 x 34
CIL-022 005 001	205 x 74 x 34



Item Code	Size in mm
CIL-022 006 001	205 x 143 x 34

The design of instrument cassettes provide the maximum protection to dental instruments for sterilization.

- Electrolyte polish.

**022 DENTAL INSTRUMENTS CASSETTES**

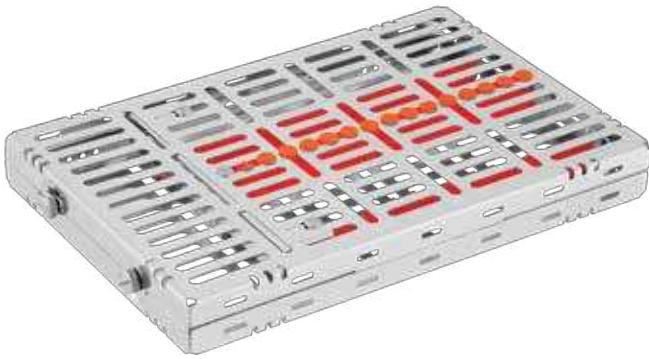

Item Code                      Size in mm  
 CIL-022 007 001                  280 x 183 x 32

For 16 Instruments with partition plate

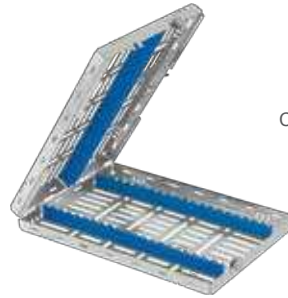

Item Code                      Size in mm  
 CIL-022 007 002                  280 x 183 x 32

For 20 Instruments



Item Code                      Size in mm  
 CIL-022 020 001                  280 x 205 x 32



Item Code                      Size in mm  
 CIL-022 009 001                  280 x 183 x 32

Silicon Inserts  
 available in different Colors



Green



Orange



Yellow



Red



Blue

022 DENTAL INSTRUMENTS CASSETTES



Spring Holding Dental Cassette

Designed specially to minimize the contact area while locking of instruments inside the cassette. Each instrument is held by separate spring. Besides it can equally hold thicker and thinner instruments in one arrangement of cassette.

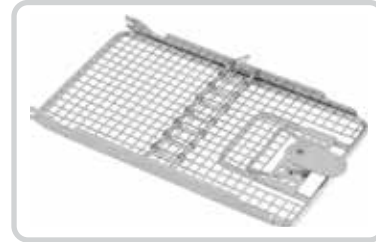

Item Code	Size in mm
CIL-022 010 001	220 x 125 x 40
CIL-022 011 001	250 x 220 x 40



Item Code	Size in mm
CIL-022 012 001	205 x 100 x 30
CIL-022 013 001	205 x 125 x 30
CIL-022 014 001	205 x 152 x 30
CIL-022 015 001	205 x 230 x 30
CIL-022 016 001	205 x 280 x 30

Double hinges cassette is much compatible design to occupy minimum space in opening position.



Item Code	Size in mm
CIL-022 017 001	235 x 80 x 30
CIL-022 018 001	240 x 90 x 40
CIL-022 019 001	235 x 155 x 40

Fine mesh dental cassette is much workable when instruments are required to be sterilized.

■ ■ **030 DENTAL INSTRUMENTS CLIP IN**



Item Code	Size in mm
CIL-030 001 001	185 x 82 x 18
CIL-030 002 001	185 x 140 x 18

Micro cassettes are the best for sterilization of micro instruments and small clamps.

**023 MICRO CASSETTE**



Item Code	Size in mm
CIL-023 001 001	40 x 55 x 20
CIL-023 002 001	74 x 45 x 20
CIL-023 003 001	74 x 59 x 24

**031 NOMENCLATURE PLATES / TAGS**

**NOMENCLATURE PLATE**



Item Code	Size in mm
CIL-031 001 001	35 x 35
CIL-031 002 001	90 x 30
CIL-031 003 001	90 x 40
CIL-031 004 001	90 x 50

**ALUMINIUM IDENTIFICATION LABEL**



Item Code	Size in mm
CIL-031 013 001	49 x 40

Item Code	Size in mm
CIL-031 014 001	49 x 17



**NOMENCLATURE PLATE**



Item Code	Size in mm
CIL-031 008 001	75 x 35

**NOMENCLATURE PLATE WITH COLOR INDICATOR**



Item Code	Size in mm
CIL-031 005 001	90 x 30
CIL-031 006 001	90 x 40
CIL-031 007 001	90 x 50

**STAINLESS STEEL TAGS**

Item Code	Size in mm
CIL-031 009 001	50 x 25
CIL-031 010 001	75 x 30



Item Code	Size in mm
CIL-031 011 001	90 x 50
CIL-031 012 001	90 x 35



■ ■ **024** IMPLANTOLOGY CASSETTES



<u>Item Code</u>	<u>Size in mm</u>
CIL- 024 001 001	180 x 148 x 50

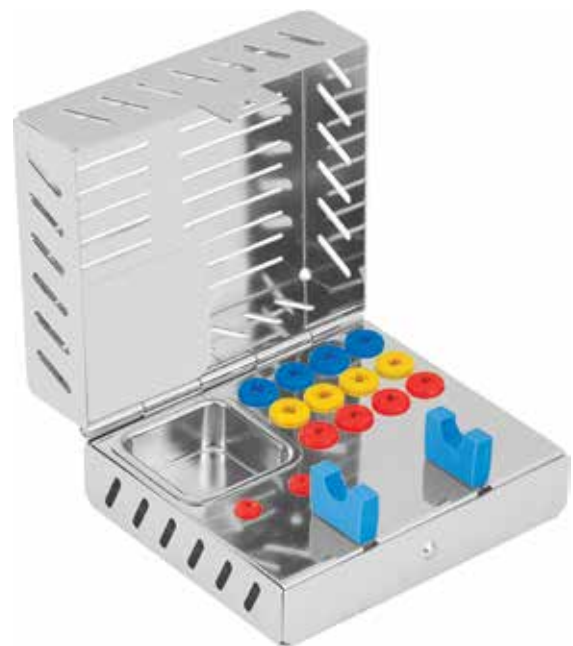

<u>Item Code</u>	<u>Size in mm</u>
CIL- 024 002 001	100 x 90 x 50



<u>Item Code</u>	<u>Size in mm</u>
CIL- 024 003 001	100 x 90 x 50

- *Implantology cassettes are strongly recommended for the process of sterilization of implant accessories.*
- *Different silicon plugs and holders are helpful in holding different burs and drills of 2 to 6.5 mm.*
- *Special silicon arrangement to hold ratchet.*
- *A separate removable compartments for various micro parts.*
- *Lids are also available without perforation.*



■ ■ **024** IMPLANTOLOGY CASSETTES

<u>Item Code</u>	<u>Size in mm</u>
CIL- 024 004 001	150 x 85 x 50

<u>Item Code</u>	<u>Size in mm</u>
CIL- 024 005 001	150 x 85 x 50

<u>Item Code</u>	<u>Size in mm</u>
CIL- 024 006 001	80 x 55 x 40

<u>Item Code</u>	<u>Size in mm</u>
CIL- 024 007 001	80 x 55 x 40

<u>Item Code</u>	<u>Size in mm</u>
CIL- 024 008 001	80 x 55 x 40





■ ■ **025** ENDODONTIC CASSETTES

Item Code      Size in mm  
 CIL-025 001 001      35 x 39 x 50      16 Holes

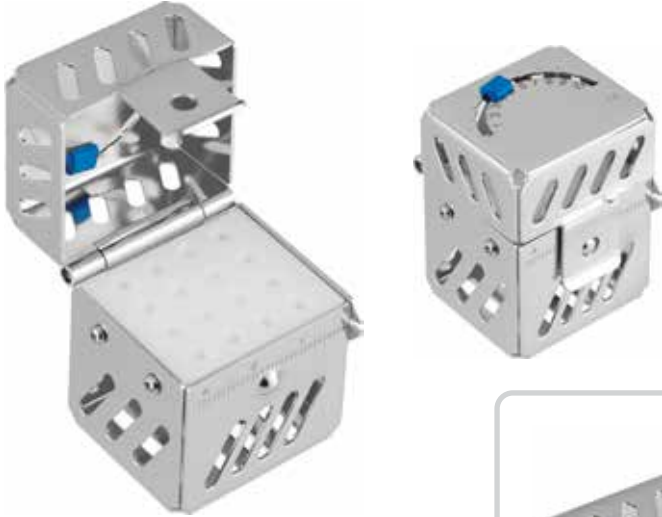

Item Code      Size in mm  
 CIL-025 002 001      65 x 43 x 50      32 Holes

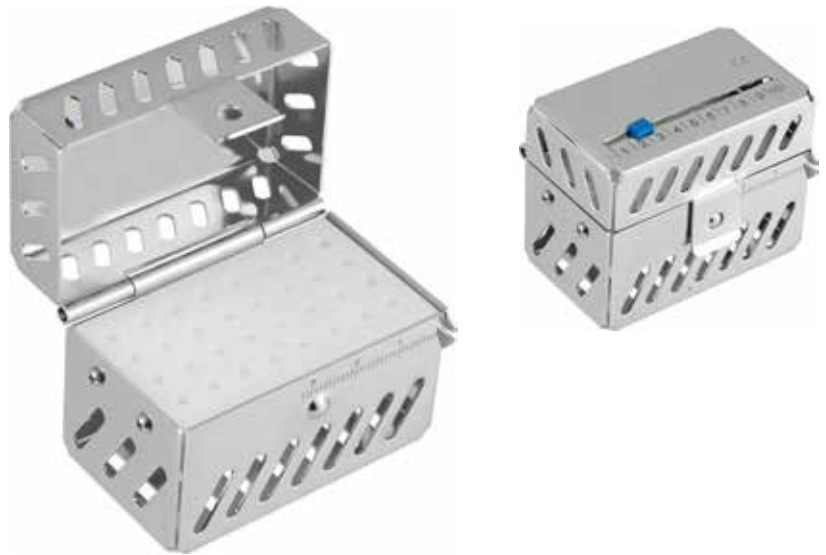

Item Code      Size in mm  
 CIL-025 003 001      65 x 43 x 82      32 Holes



- Reinforced with teflon arrangement withing holes that gives immense care while washing, disinfection and sterilization of burrs and drills.
- Having counter with silicon indicator.



■ ■ **028 BUR CLIPS**



Item Code	Size in mm	
CIL-028 001 001	35 x 28 x 28	8 Holes
CIL-028 002 001	45 x 38 x 28	14 Holes
CIL-028 003 001	60 x 45 x 28	17 Holes

**029 BUR HOLDER & STAND**



Item Code	Size in mm
CIL-029 001 001	75 x 20 x 40
CIL-029 001 002	75 x 20 x 50
CIL-029 001 003	75 x 20 x 60
CIL-029 001 004	75 x 20 x 70



Item Code	Size in mm	
CIL-029 006 001	63 x 25 x 30	Plug in 12 holes 2 Rows of 6 Holes
CIL-029 008 001	110 x 35 x 34	Plug in 30 holes 3 Rows of 10 Holes

## 018 PERFORATED SHEET TRAYS



**(With Handle)**

Item Code	Size in mm
CIL-018 001 001	240 x 240 x 50

Stainless steel perforated sheet trays are used for some special sterilizers.

- Gloss finish and burr free smooth finish.



Item Code	Size in mm
CIL-018 002 001	275 x 210 x 45



Item Code	Size in mm
CIL-018 003 001	240 x 250 x 50
CIL-018 003 002	240 x 250 x 70
CIL-018 004 001	480 x 250 x 50
CIL-018 004 002	480 x 250 x 70
CIL-018 005 001	480 x 480 x 50
CIL-018 005 002	480 x 480 x 70

## 019 EDINBURGH ALUMINIUM SHEET TRAYS

Item Code	Size in mm
CIL-019 001 001	305 x 305 x 38
CIL-019 002 001	610 x 305 x 38
CIL-019 003 001	305 x 305 x 51
CIL-019 004 001	457 x 305 x 51
CIL-019 005 001	457 x 381 x 51
CIL-019 006 001	457 x 457 x 51
CIL-019 007 001	457 x 610 x 51
CIL-019 008 001	432 x 584 x 51

Aluminum trays are light in weight with smooth anodized finish. Available with and without perforation. Also available in color anodizing.





## 020 TRINKET BOXES



**(Lid perforated)**

Item Code	Size in mm
CIL-020 001 001	90 x 60 x 25
CIL-020 002 001	105 x 70 x 25
CIL-020 003 001	120 x 80 x 25
CIL-020 004 001	150 x 100 x 25
CIL-020 005 001	205 x 105 x 35



**(Lid Wire Mesh)**

Item Code	Size in mm
CIL-020 001 002	90 x 60 x 25
CIL-020 002 002	105 x 70 x 25
CIL-020 003 002	120 x 80 x 25
CIL-020 004 002	150 x 100 x 25
CIL-020 005 002	205 x 105 x 35

## 032 MEDICAL / LABORATORY SIEVES

Item Code	Size in mm
CIL- 032 002 001	diameter 45
CIL- 032 003 001	diameter 55
CIL- 032 005 001	diameter 65

*Medical sieves are used for delicate micro medical instruments for sterilization.*

Item Code	Size in mm
CIL-032 005 001	140
CIL-032 006 001	200

Item Code	Size in mm
CIL- 032 002 002	diameter 45
CIL- 032 003 002	diameter 55
CIL- 032 005 002	diameter 65



**021 SURGICAL NEEDLE CASES**

<u>Item Code</u>	<u>Size in mm</u>		<u>Item Code</u>	<u>Size in mm</u>
CIL-021 001 001	150 x 90 x 15		CIL-021 004 001	50 x 30 x 8
CIL-021 002 001	210 x 125 x 17		CIL-021 005 001	65 x 45 x 8
			CIL-021 006 001	80 x 30 x 8

<u>Item Code</u>	<u>Size in mm</u>
CIL-021 003 001	65 x 15

**055 DENTAL BOX**

<u>Item Code</u>	<u>Size in mm</u>
CIL-055 001 001	280 x 180 x 40

**056 TEST TUBE STAND**

<u>Item Code</u>	<u>Size</u>
CIL-056 001 001	12 Tubes Nos.

**057 ENDODONTIC BOX**

<u>Item Code</u>	<u>Size in mm</u>
CIL-057 001 001	105 x 45 x 50

**014 PRF BOX**

<u>Item Code</u>	<u>Size in mm</u>
CIL-014 001 001	180 x 80 x 45

## 040 INSTRUMENTS TRAY



Item Code With Lid	Item Code Without Lid	Size in mm
CIL-040 001 501	CIL-040 001 001	200 x 100 x 25
CIL-040 002 501	CIL-040 002 001	200 x 150 x 40
CIL-040 003 501	CIL-040 003 001	230 x 150 x 50
CIL-040 004 501	CIL-040 004 001	250 x 140 x 50
CIL-040 005 501	CIL-040 005 001	250 x 200 x 50
CIL-040 006 501	CIL-040 006 001	300 x 200 x 50
CIL-040 007 501	CIL-040 007 001	300 x 250 x 50
CIL-040 008 501	CIL-040 008 001	350 x 250 x 50
CIL-040 009 501	CIL-040 009 001	350 x 300 x 50
CIL-040 010 501	CIL-040 010 001	400 x 300 x 50
CIL-040 011 501	CIL-040 011 001	450 x 300 x 50
CIL-040 012 501	CIL-040 012 001	425 x 225 x 50

## 042 CATHETER TRAY

Item Code	Size in mm
CIL-042 001 001	250 x 75 x 40
CIL-042 002 001	230 x 80 x 50
CIL-042 003 001	300 x 80 x 40
CIL-042 004 001	350 x 90 x 45
CIL-042 005 001	400 x 100 x 50



## 041 INSTRUMENT BOX

Item Code	Size in mm
CIL-041 001 001	150 x 80 x 40
CIL-041 002 001	170 x 70 x 30
CIL-041 003 001	180 x 80 x 40
CIL-041 004 001	200 x 100 x 40
CIL-041 005 001	230 x 120 x 50
CIL-041 006 001	250 x 125 x 50
CIL-041 007 001	300 x 140 x 60
CIL-041 008 001	300 x 150 x 50
CIL-041 009 001	300 x 200 x 50
CIL-041 010 001	350 x 175 x 65
CIL-041 011 001	350 x 180 x 60
CIL-041 012 001	400 x 200 x 90
CIL-041 013 001	500 x 200 x 120

## 043 KIDNEY TRAYS

Shallow Type (A)	
Item Code	Size in mm
CIL-043 001 001	170
CIL-043 002 001	220
CIL-043 003 001	240
Without Lid (B,C)	
Item Code	Size in mm
CIL-043 004 001	150
CIL-043 005 001	180
CIL-043 006 001	200
CIL-043 007 001	250
CIL-043 008 001	280
With Lid (D)	
Item Code	Size in mm
CIL-043 004 002	150
CIL-043 005 002	180
CIL-043 006 002	200
CIL-043 007 002	250
CIL-043 008 002	280

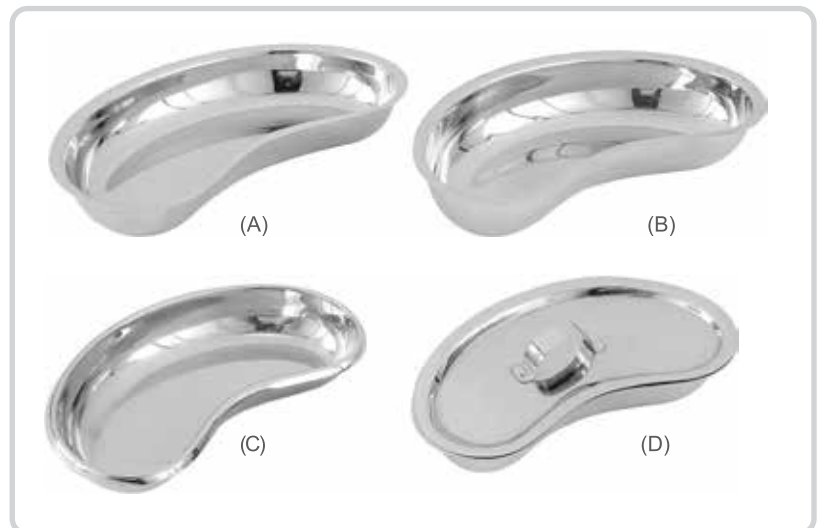

## 044 DRESSING DRUM



Item Code	Size in mm
CIL-044 001 001	80 x 80
CIL-044 002 001	120 x 120
CIL-044 003 001	130 x 290
CIL-044 004 001	150 x 140
CIL-044 005 001	160 x 120
CIL-044 006 001	180 x 180
CIL-044 007 001	200 x 190
CIL-044 008 001	240 x 240
CIL-044 009 001	290 x 240
CIL-044 010 001	340 x 240
CIL-044 011 001	390 x 200
CIL-044 012 001	390 x 290
CIL-044 013 001	390 x 390

## 013 BOWLS

### Wash Basin



Item Code	Size in mm
CIL-013 001 001	300
CIL-013 001 002	350
CIL-013 001 003	400
CIL-013 001 004	450



Item Code	Size in mm
CIL-013 002 001	80 x 35
CIL-013 002 002	104 x 50
CIL-013 002 003	165 x 60
CIL-013 002 004	203 x 65
CIL-013 002 005	260 x 100
CIL-013 002 006	300 x 115
CIL-013 002 007	340 x 120
CIL-013 002 008	380 x 120

Item Code	Size in mm
CIL-013 003 001	80
CIL-013 003 002	100
CIL-013 003 003	120
CIL-013 003 004	140
CIL-013 003 005	150
CIL-013 003 006	180

### Lotion Bowls



### Gallipot



### Gallipot



### Iodine Cup



Item Code	Item Code	Item Code	Size in Oz
CIL-013 004 001	CIL-013 005 001	CIL-013 006 001	2
CIL-013 004 002	CIL-013 005 002	CIL-013 006 002	4
CIL-013 004 003	CIL-013 005 003	CIL-013 006 003	6
CIL-013 004 004	CIL-013 005 004	CIL-013 006 004	8
CIL-013 004 005	CIL-013 005 005	CIL-013 006 005	10
CIL-013 004 006	CIL-013 005 006	CIL-013 006 006	12
CIL-013 004 007	CIL-013 005 007	CIL-013 006 007	14
CIL-013 004 008	CIL-013 005 008	CIL-013 006 008	16

## 045 DRESSING JAR



Item Code	Size in mm
CIL-045 001 001	80 x 80
CIL-045 002 001	90 x 90
CIL-045 003 001	100 x 80
CIL-045 004 001	100 x 100
CIL-045 005 001	120 x 120
CIL-045 006 001	125 x 100
CIL-045 007 001	150 x 150

## 046 FORCEPS JAR



Item Code	Size in mm
CIL-046 001 001	30 x 80
CIL-046 002 001	40 x 90
CIL-046 003 001	180 x 50
CIL-046 004 001	200 x 65
CIL-046 005 001	200 x 100

## 047 WASTE COLLECTOR



Item Code	Size
CIL-047 001 001	Standard

## 059 COTTON DISPENSER



Item Code	Size
CIL-059 002 001	Standard

## 051 BED PANS

Perfection



Slipper



Item Code	Size
CIL-051 001 001	(Adult) Perfection
CIL-051 001 002	(Child) Perfection
CIL-051 002 001	(Adult) Slipper
CIL-051 002 002	(Child) Slipper
CIL-051 003 001	Fracture

## 052 URINALS

Male Urinal



Item Code	Size
CIL-052 001 001	Standard



Urinal Jug

Item Code	Size
CIL-052 002 001	Standard

Female Urinal



Item Code	Size
CIL-052 003 001	Standard

## 054 IRRIGATOR

(Deuche Can)



Item Code	Size in Ltr.
CIL-054 001 001	1.0
CIL-054 002 001	1.5
CIL-054 003 001	2.0

## 053 MEASURING JUG



Item Code	Size in ml
CIL-053 001 001	250
CIL-053 002 001	500
CIL-053 003 001	1000

## 058 SCALER TRAYS



Item Code	Size in mm
CIL-058 001 001	200 x 100
CIL-058 002 001	205 x 115
CIL-058 003 001	210 x 150
CIL-058 004 001	220 x 130
CIL-058 005 001	225 x 100





■ ■ ■ CUSTOMIZED PRODUCTS

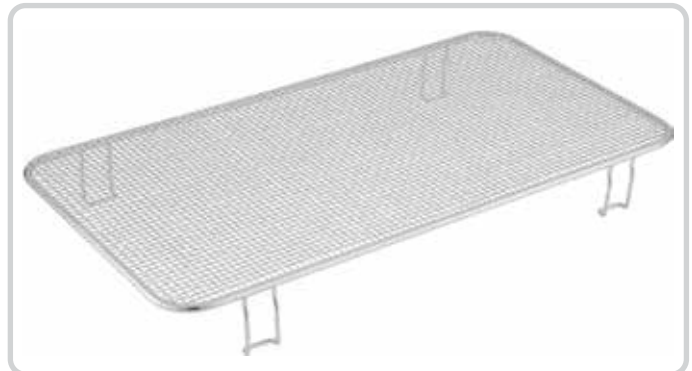
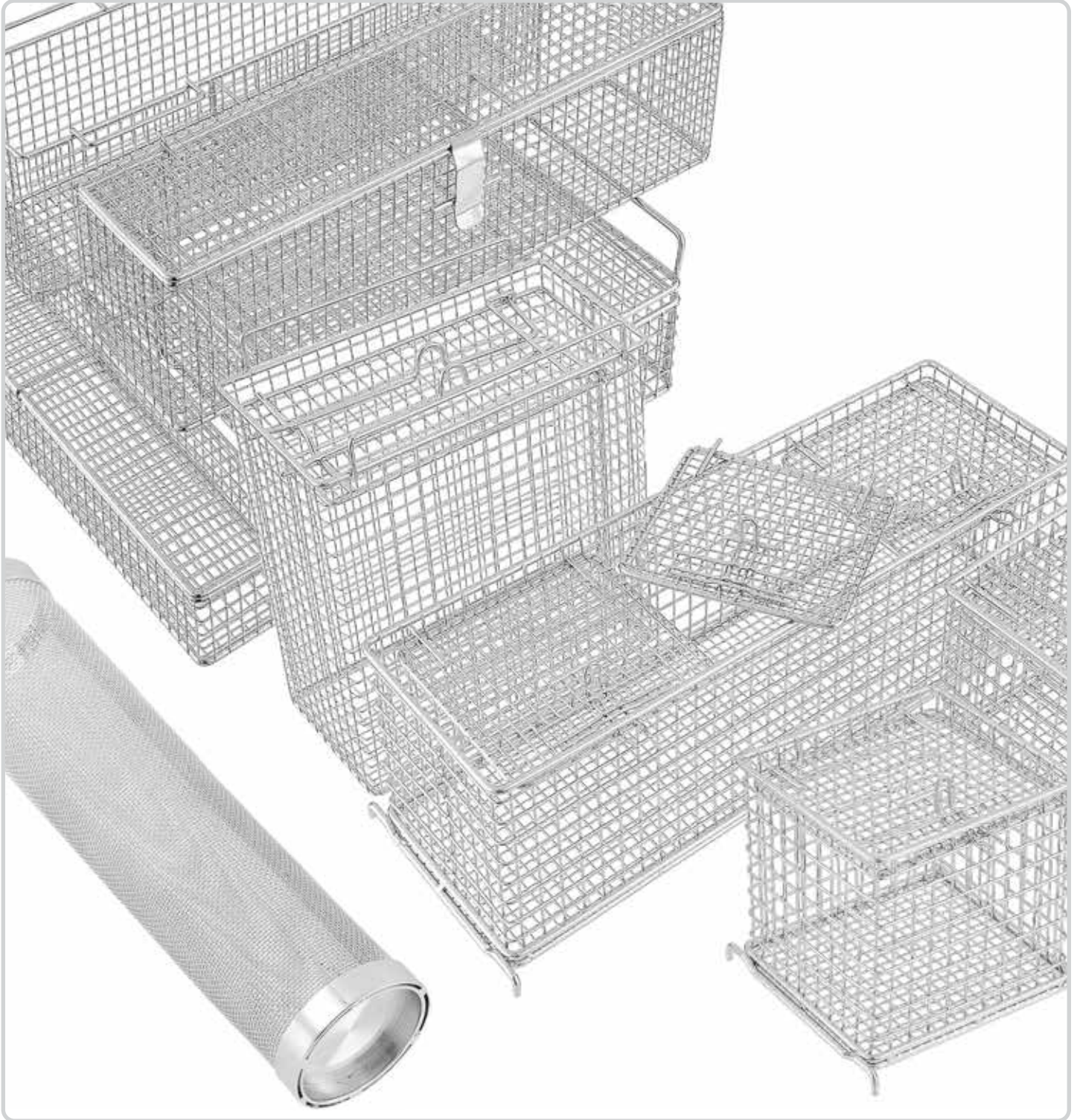



## **Rosh Biomedical Inc**

37 -Kamori Road , Caledon, Ontario Canada

Tel: 437-922-2279 |

Email: [roshbiomedical@outlook.com](mailto:roshbiomedical@outlook.com)

Web: [www.Roshbiomedical.com](http://www.Roshbiomedical.com)